

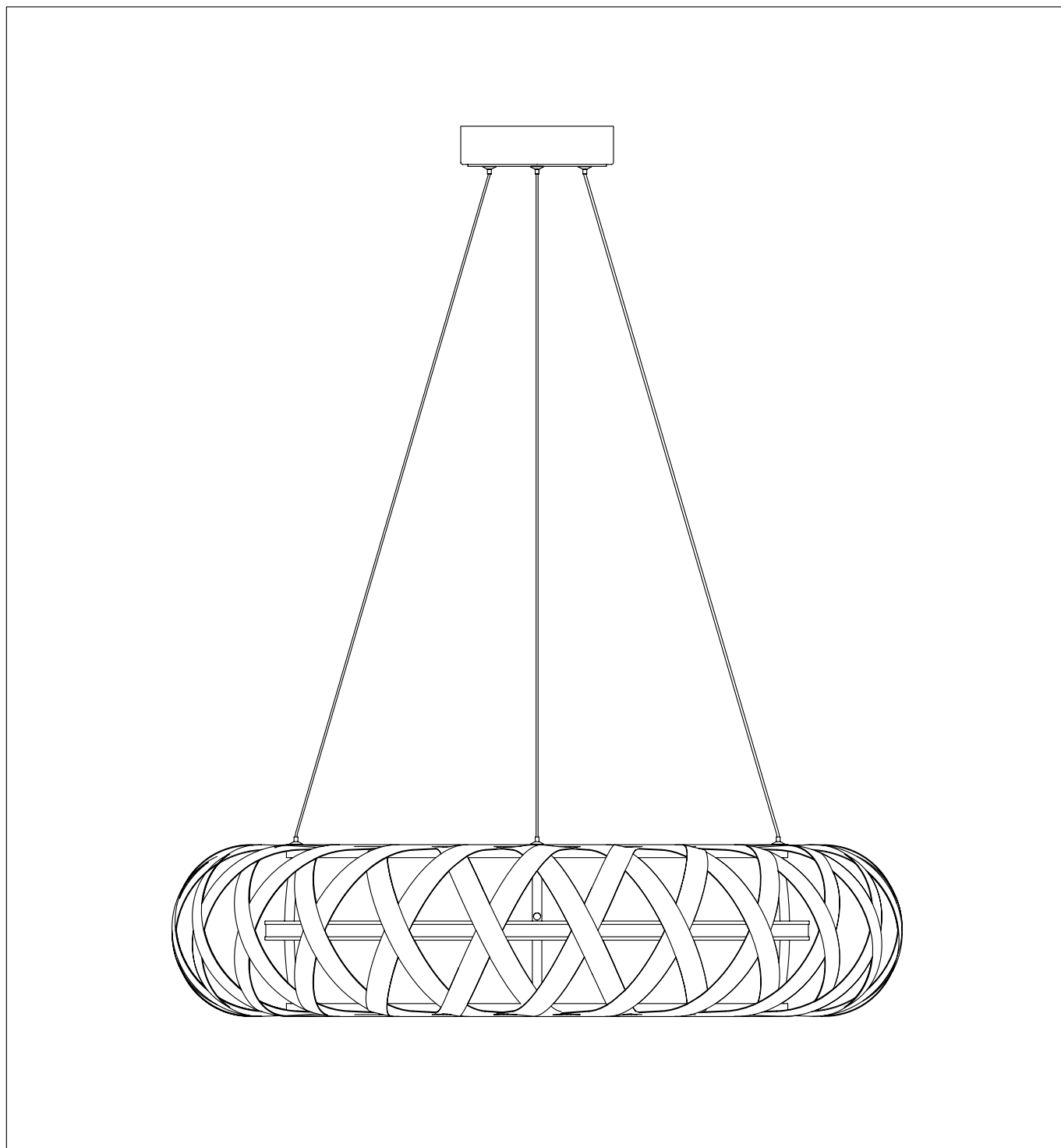

PRODUCT NAME: WEAVE

ITEM NUMBER: 35055BZGTGLD

Please consult your electrician for hanging fixture and wiring.



LED 1X40W (Bulb included)

IMPORTANT: Turn off the power at the main fuse or circuit breaker box before starting installation.

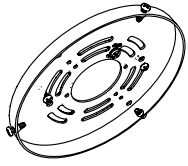

Mounting Strap (A)

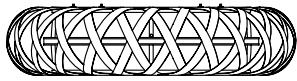

Body (B)

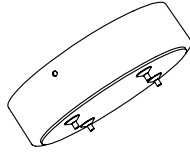

Canopy (C)

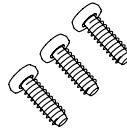

Screw (D)

Locate all hardware & components before discarding packaging

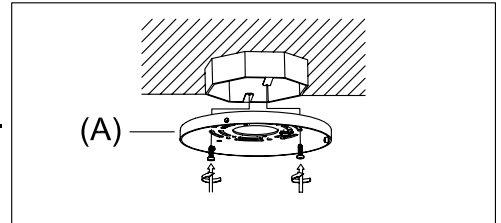
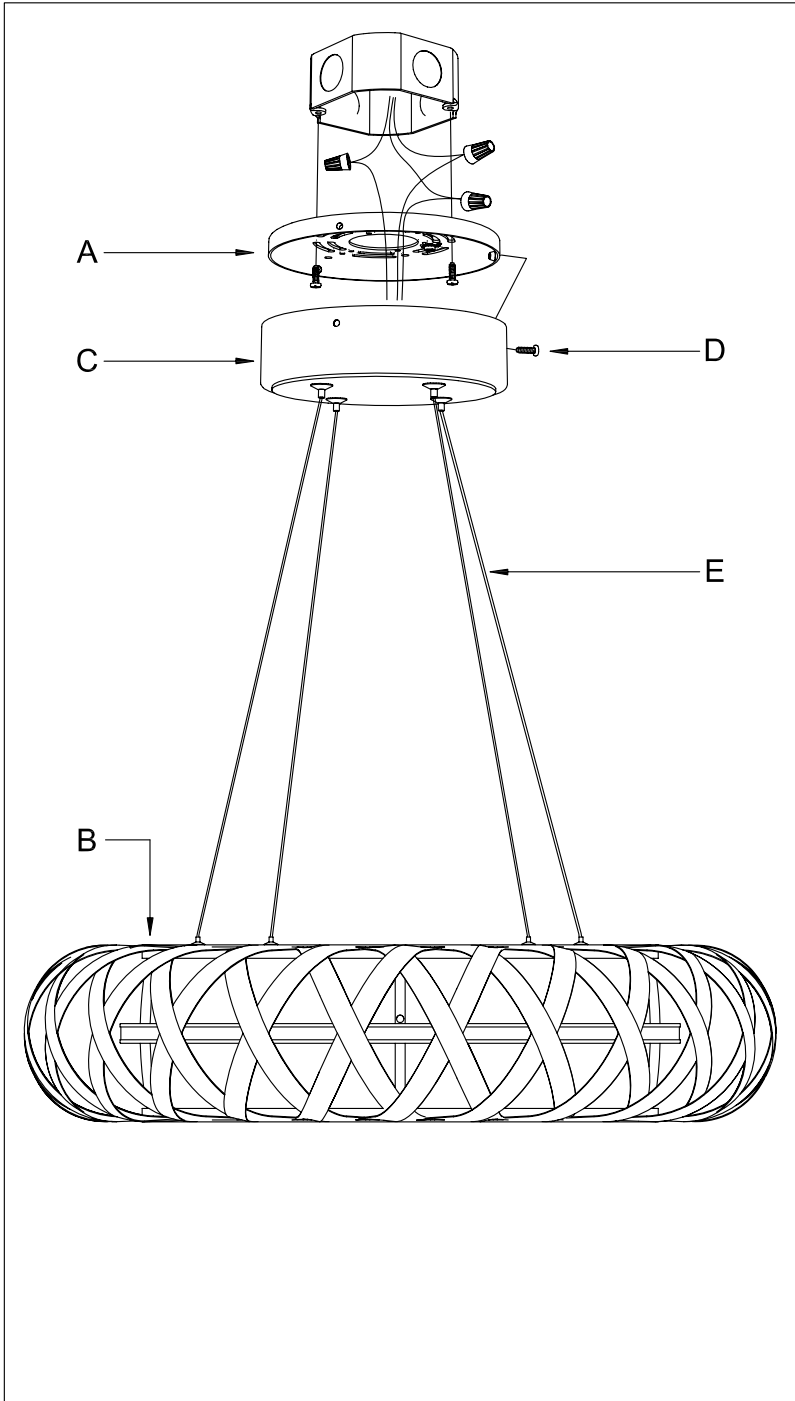

1).

Step.1: Remove mounting bracket (A) from fixture and install to electrical box.

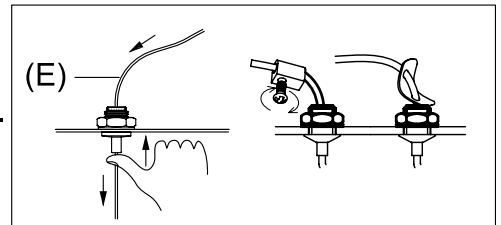

2).

Step.2: Press the wire restraint to adjust the desired length of cable. Secure the cables.

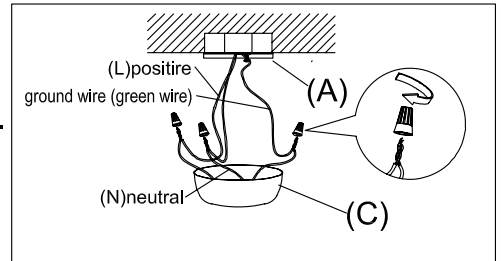

3).

Step.3: Wire fixture to wires in outlet box. Green wire is fo Ground.

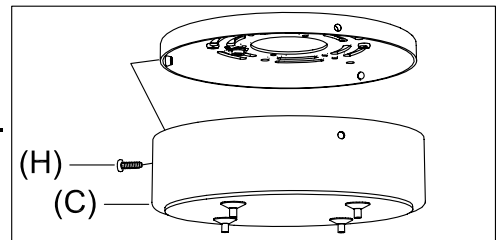

4).

Step.4: Install body (B) to Mounting Strap (A) and tighten Screw (H) through the hole of canopy (C) on the Mounting Strap (A).

Cleaning & Care:

Clean with soft cloth and a mild detergent.
Do not use abrasive cleaner.